



Subaru Liberty/Legacy w/ EZ30 H6

2004 – 2009 Year models

Supercharger System fitment guide



Table of Contents

Subaru Liberty/Legacy w/ EZ30 H6	1
SAFETY INFORMATION	3
TOOLS	3
THE INSTALLATION	5
Supercharger system installation.....	6
Install fuel injectors	6
THE ENGINE DRIVE BELT	14
BELT ROUTING – NEW	15
Electrics.....	16
FAN Wiring guide.....	18
ENGINE COVER	19
2. FINAL CHECKS BEFORE STARTING VEHICLE.....	19
OPTIONAL MAP SENSOR.....	20
Using Intercoolers	21
Servicing suggestion	22
Fitted images.....	23

SAFETY INFORMATION

- REMOVE THE KEY FROM THE IGNITION OF THE CAR – THE CAR MUST BE COMPLETELY OFF – NOT EVEN THE CAR RADIO ON.
- DO NOT SMOKE NEAR THE CAR.
- NO NAKED FLAMES OR OTHER IGNITION SOURCES.
- PRE-READ ALL INSTRUCTIONS BEFORE STARTING
- WEAR SUITABLE PPE FOR THIS TASK i.e. GLOVES, EYE PROTECTION
- ASSESS ANY OTHER POTENTIAL DANGERS AT YOU FITTING SITE BEFORE YOU BEGIN THE INSTALLATION - PUT PROTECTIVE MEASURES IN PLACE
- DO NOT DRINK ALCOHOL DURING THIS EXERCISE
- Do a TAKE 5 safety assessment and assess all hazards and the controls you will put in place for those – for your safety
- When fitting/upgrading the fuel pump – this is extremely dangerous work, do not perform this task if you are not qualified to do so
- ALLOW 2 HOURS ON AVERAGE FOR FULL KIT INSTALL – IT'S NOT A RACE. ACCURACY/ATTENTION TO DETAIL IS MORE IMPORTANT THAN SPEED!!

TOOLS

- Phillips head screw drivers
- Flat head screw drivers
- 10, 12, 13 and 14mm sockets
- Soldering iron (to connect cooling fan wires)
- Side cutters (trim zip ties)
- Electrical wiring crimp set
- Box cutter knife to trim hoses to length
- Allen Key set – metric with 6mm Key
- Standard socket set, wrenches all metric
-

PARTS LIST – Complete NON IC KIT

- 6 x 550cc
- 1 x complete supercharger bracket with all idlers assembled onto bracket
- 1 x Raptor VL 30 Supercharger
- 1 x Thick alloy stay bracket with 2 x long 8mm bolts
- 1 x 6PK 2275 drive belt
- 1 x Air filter mounting assembly with screws to attach
- 1 x Air filter
- 1 x 32mm BOV (GREDDY TYPE FV)
- 1 x Air charge pipe with integral AFM mount
- 2 x silicon bends
- 5 x Hose clamps 3"
- 1 x Hose clamp 2.5"
- 1 x 300mm length of flexi 3.5" Hose
- 1 x 1500mm length of 12mm breather hose with push in connector – no clamps provided
- 1 x 500mm length of 32mm BOV connector hose 1 clamp provided
- Engine cover mounting strips – stainless steel
- Supercharger cooling fan kit, bracket, fan, fused wiring, hose and hose adaptor

THE INSTALLATION

1. Remove the factory air intake system. Start by removing the 2 screws which fasten the cold air intake to the front of car, this piece then pulls away directly out of the air box.
 - Undo the 2 clamps and remove flexi hose section between air box and resonator chamber (at back of throttle body)
 - Unclip back section of air filter box and remove, also unclip power steering hose from the support on this piece also. Unplug the AFM plug before you entirely remove the piece. Unclip the AFM wiring loom from the side of the front piece of air box
 - Undo the 2 x 10mm fasteners that retain the front part of the air box to vehicle, one is inside the air box nearest the mud guard and the other is down on the chassis requiring a 300mm extension for your socket.
 - Remove this front part of air box from car, it has a **MASSIVE protrusion at the bottom of it that you need to wriggle free**, it is easy to do this.
 - Remove main engine cover, there are 2 plastic fasteners at the rear of this piece.
 - Undo the 2 x 12 mm bolts that retain the resonator chamber to the throttle body as well as loosen the hose clamp. DON'T forget to remove the breather hose from the left hand side of this chamber.



This image shows part of the air intake removed

Supercharger system installation

Install fuel injectors

22.Fuel

A: PROCEDURE

1. RELEASING OF FUEL PRESSURE

WARNING:

- Place “NO FIRE” signs near the working area.
- Be careful not to spill fuel on the floor.

1) Remove the fuse of fuel pump from main fuse box.

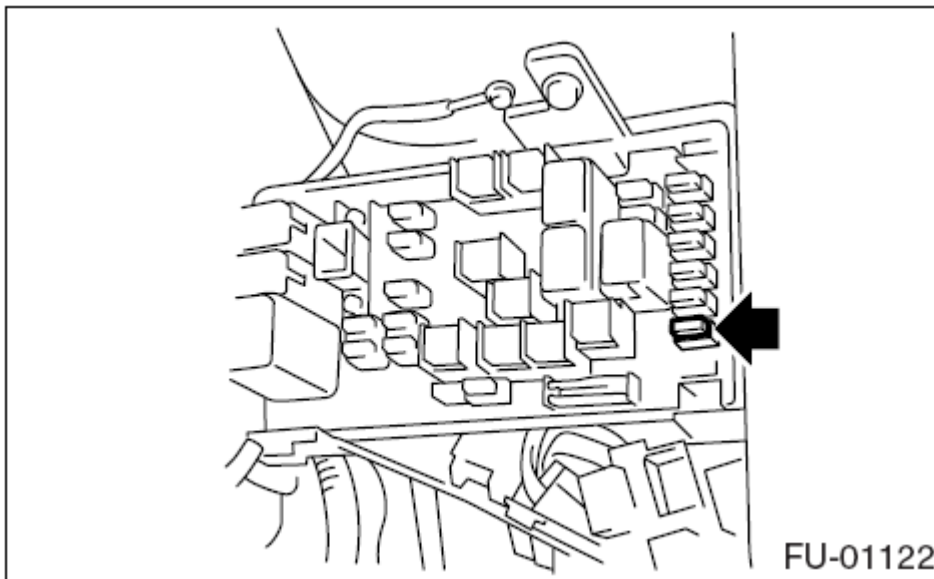

2) Start the engine and run until it stalls.

3) After the engine stalls, crank it for five more seconds.

Fuel Injector

FUEL INJECTION (FUEL SYSTEMS)

12. Fuel Injector

A: REMOVAL

1. RH SIDE

- 1) Remove the collector cover.
- 2) Release the fuel pressure.
<Ref. to FU(H6DO)-39, RELEASING OF FUEL PRESSURE, PROCEDURE, Fuel.>
- 3) Open the fuel filler flap lid, and remove the fuel filler cap.
- 4) Disconnect the ground cable from battery.

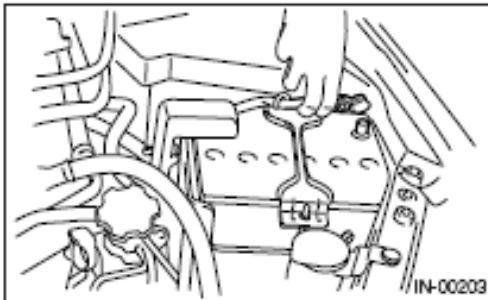

- 5) Remove the air cleaner case. <Ref. to IN(H6DO)-5, REMOVAL, Air Cleaner Case.>
- 6) Remove the fuel pipe protector RH.

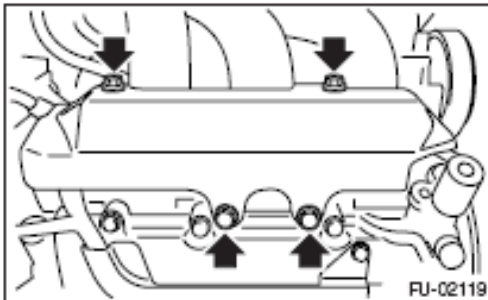

- 7) Disconnect the connectors from fuel injector.

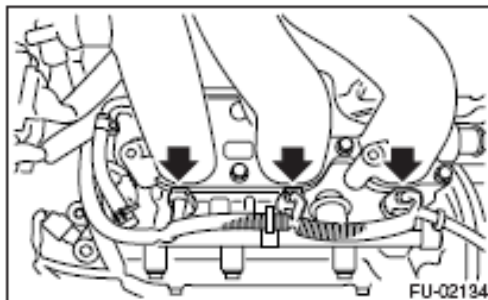

- 8) Remove the engine harness from fuel injector pipe RH.

- 9) Remove the bolts which hold fuel injector pipe onto intake manifold.



- 10) Remove the fuel injector while lifting up the fuel injector pipe.

2. LH SIDE

- 1) Remove the collector cover.
- 2) Release the fuel pressure.
<Ref. to FU(H6DO)-39, RELEASING OF FUEL PRESSURE, PROCEDURE, Fuel.>
- 3) Open the fuel filler flap lid, and remove the fuel filler cap.
- 4) Remove the battery.
- 5) Remove the generator harness from fuel pipe protector LH.
- 6) Remove the fuel pipe protector LH.

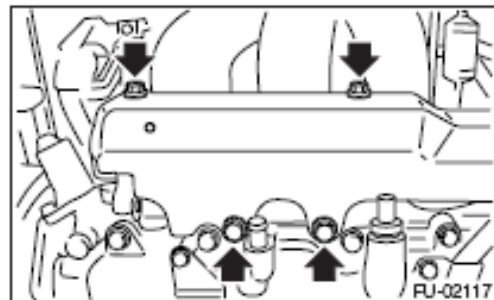

- 7) Disconnect the connectors from fuel injector.

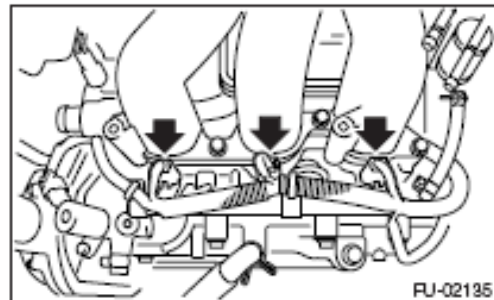

- 8) Remove the engine harness from fuel injector pipe LH.

Fuel Injector

FUEL INJECTION (FUEL SYSTEMS)

9) Remove the bolts which hold fuel injector pipe onto intake manifold.

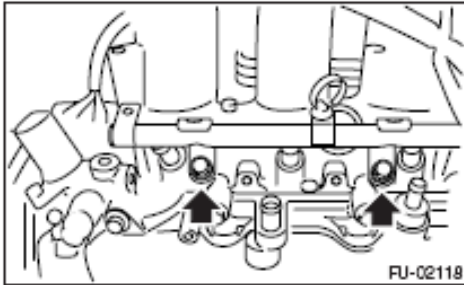

10) Remove the fuel injector while lifting up the fuel injector pipe.

B: INSTALLATION

1. RH SIDE

Install in the reverse order of removal.

NOTE:

Use new O-rings.

Tightening torque:

19 N·m (1.9 kgf-m, 13.7 ft-lb)

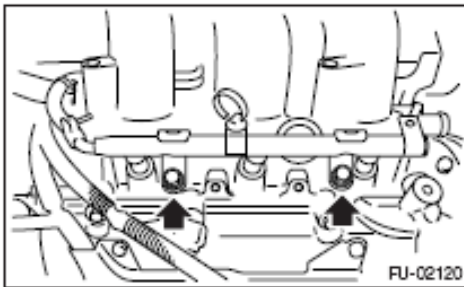

Tightening torque:

19 N·m (1.9 kgf-m, 13.7 ft-lb)

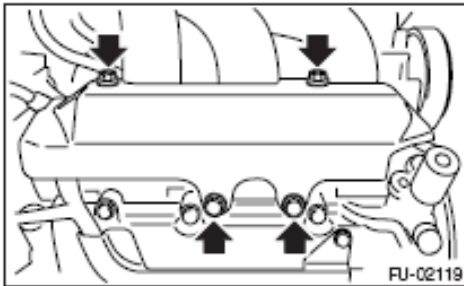

2. LH SIDE

Install in the reverse order of removal.

NOTE:

Use new O-rings.

Tightening torque:

19 N·m (1.9 kgf-m, 13.7 ft-lb)

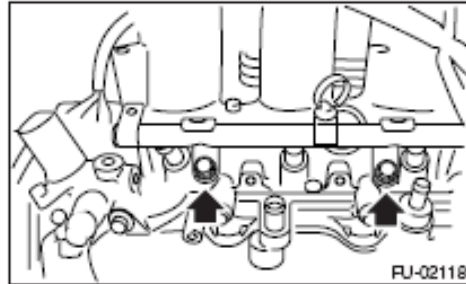

Tightening torque:

19 N·m (1.9 kgf-m, 13.7 ft-lb)

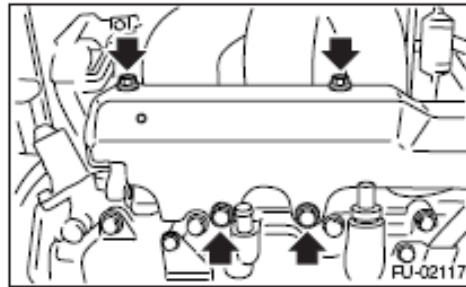

- Fit air filter to air filter mount and then fit mount to car chassis with the supplied 12 mm screws. Also fit the breather hose 12mm to the breather hose connection on this mount. Then fit the 3" flexi hose and the 32mm flexi hose to the appropriate connections on the mount
- On pre facelift models. There is a power steering line along the chassis rail. Remove one bolt from the line clamp and slip the bracket below and screw down.

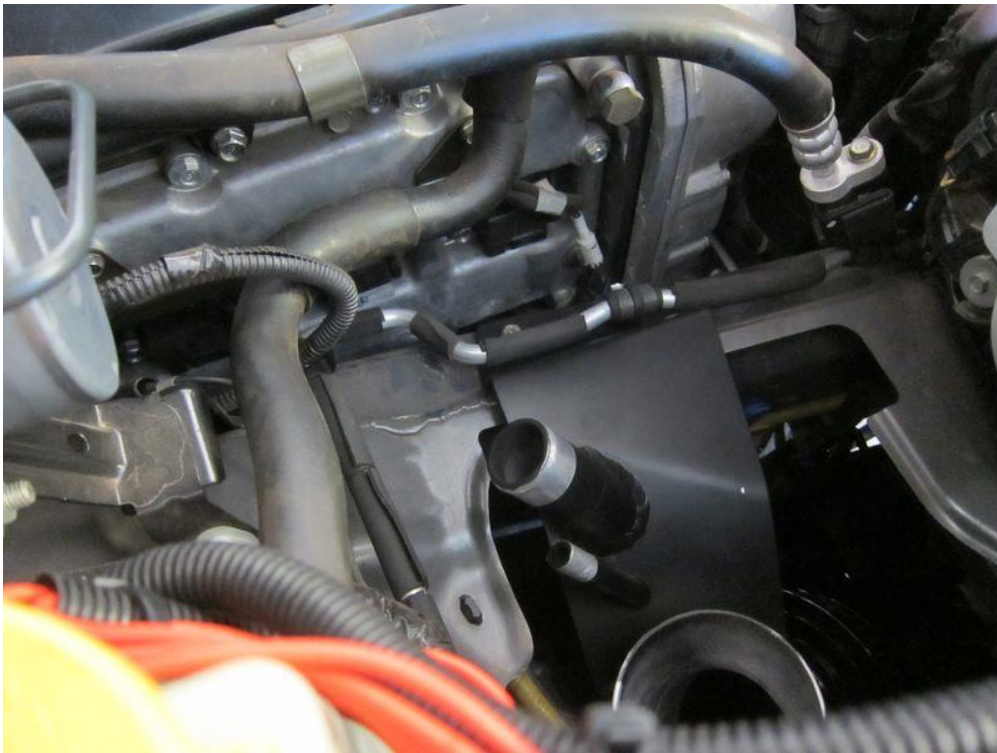

- Tighten hose clamps properly, once the supercharger goes above this part you can no longer access this item although the supercharger is very easy to remove to gain access.
- Continuing with air intake to supercharger - You will need to trim the 3.25" flex hose to length – need knife and side cutters and clamp to the adapter.

- Option: If desired once the flex hose is installed. You can seal the opening above the air filter. Use a heat reflective foam material such as “Proshield”. This will help prevent engine bay hot air from entering the air filter area.
- Remove the bolts from the power steering pump and from adjacent support (see image below) as shown (2 x 12mm) as shown in image below, you will reuse these 2 bolts in their original locations.
- If the holes do not line up to enable bolt removal. The drive belt can now be removed to enable the power steering pump pulley to be rotated.



- Next remove 2 of the injector cover bolts and install the Alloy support arm, fit the hydraulic oil hoses through the brace and temporarily leave the new attaching bolts a couple of turns loose – to be tightened later.

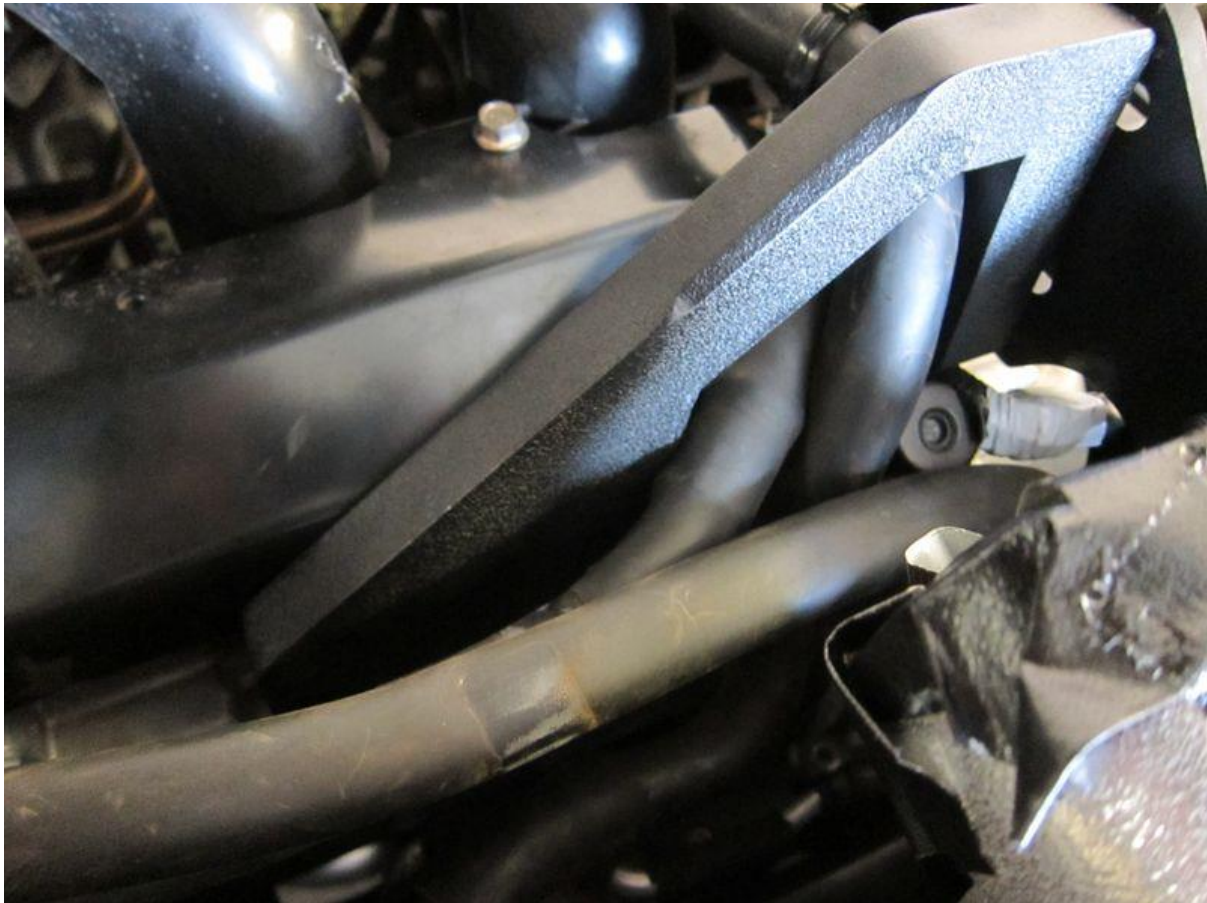

- Now fit the entire supercharger bracket assembly as a complete piece, simply slide it in from the side – the clearance behind the power steering pulley is VERY

close so take care to not scratch too much paint off your new bracket. TAKE GREAT CARE TO NOT DAMAGE THE CAMSHAFT CONTROL WIRES AND PLUG.

- The image below shows an incomplete bracket installed, you should be installing a complete bracket with supercharger attached. Weight is approx 8kg – make sure you can control the piece single handed OR get assistance



- Install the 2 bolts at the power steering pump end of the bracket and then install the 2 button head screws into the end of the stay arm bracket, wriggle it all around until you can get the screws in, they may not appear to go in easily at first. Do not tighten them up. Once all screws/bolts are started into their threads then tighten the 2 bolts at the power steering pump – **first make sure the bracket is approximately level** – tight bolts to factory torque settings. Next tighten the 2 button head screws with Allen Key and finally tighten the 2 x 13mm head bolts in the stay bracket – Your Supercharger is now mounted
- REMOVE THE AFM sensor from your factory Subaru air box, you will need a Phillips head screw driver.
- **After you remove the sensor check that it is CLEAN, the little black shiny bulb (the IAT) sensor needs to be glossy and shiny all over, if a dull slightly creamy colour on one side then clean it with a high quality electrical contact cleaning fluid and a very soft tissue. This is something you should check every few months to be sure it remains clean as this can significantly affect the tune.**

- Install your sensor in your boost charge pipe, it can only fit correctly, if the screw holes don't line up then rotate the sensor 180 degrees. You have been supplied new screws to fasten the sensor, they could possibly be too long so screw them in carefully and see if they bottom out. Do not pull the screws down too tight on the AFM sensor; it is possible to crack the sides off the sensor.
- Connect the **supplied vacuum hose using the barbed end to engage the original breather hose**, run around to the air filter mount, cut to length and fit onto the 12mm fitting and hose clamp. Zip tie the hose securely away from anything that could damage it. No clamp is needed at the barbed end.
- Fit the 32mm BOV to boost pipe with outlet facing away from the AFM sensor side, always connect to the **upper fitting** on the BOV, not to the small fitting at the bottom. If you get this incorrect the valve will malfunction. Your vacuum hose to actuate the BOV needs to **connect into the FPR regulator line** with the supplied vacuum Tee.
-





- Fit the 90 degree 2.5" – 3" silicon fitting to the supercharger and the 3" bend onto the throttle body and then install the boost pipe. Tighten clamps securely once you have the pipe sitting comfortably.
- Connect the AFM wires, you may need to unclip a couple of the AFM harness clips so as the plug will reach the AFM in its new location. There is plenty of length available. Zip tie cable securely

THE ENGINE DRIVE BELT

- This is one of your last tasks, **first take extremely good note of how the engine belt is routed.** The image below indicates which pulley is the autotensioner pulley, you will need a 14mm socket for this task. Fit your socket and ratchet to the bolt on this pulley then **rotate your spanner clockwise** to force pulley down which in turn will loosen the belt, slide the belt off one of the plain idlers and

then release the spring loaded idler tension pulley slowly until it goes right through its travel and stops.



BELT ROUTING – NEW

Supercharger is to the far left, the Air Conditioning compressor to the far right and the crank pulley is the lowest. Route the belt and once you have moved the autotensioner back to full tension then slide the last bit of belt onto a plain faced idler pulley. Then inspect the belt and **BE CERTAIN** your belt is properly seated into the micro grooves on each of the pulleys, failure to do so can lead to immediate ruination of the belt.

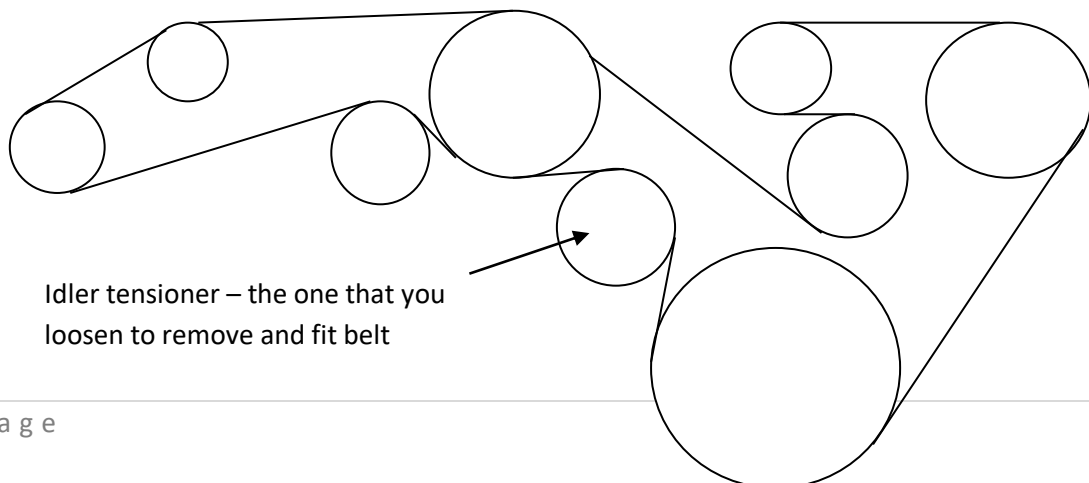

Electrics

Additionally check that the wiring for your cam phaser is clear of the drive belt. Zip tie as necessary. For early H6 models make certain the power steering line is pressed and zip tied down to clear the charger bracket.

Supercharger cooling system

FOR AIR COOLED SUPERCHARGERS

- Mount the supercharger charger cooler fan module to a suitable COLD AIR location between front bumper and radiator.
- Install wiring for cooler fan to a 12V switched source. The supercharger cooling fan should be fitted into the area behind the front bumper (bumper removal needed), it must never be mounted in the engine bay. The fan should run anytime that the ignition key is in the "ON" position. The fans max power demand is 420w or 12 Volts @ 35amp (start current), a decent amount. Mount the fan on the supplied bracket, then connect hose to fan with hose clamp and simply push the other end convoluted hose onto the fitting on the supercharger transmission.. For both (intercooler pump) or aircooled supercharger fan, connect the piggyback adaptor into CABIN fuse box as shown below. This is beside the drivers right knee



- .. For both (intercooler pump) or aircooled supercharger fan, connect the piggyback adaptor into CABIN fuse box as shown below. This is beside the drivers right knee

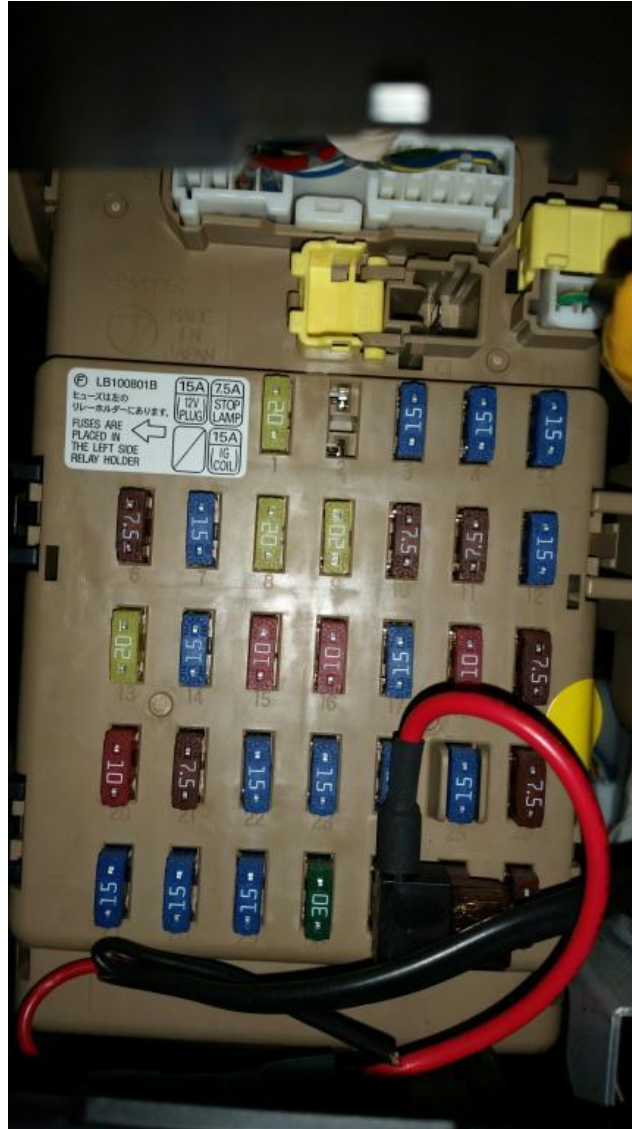

The fan controller w/variable speed unit
(set to 60% of max)

FAN Wiring guide

PIN NUMBERS ARE NOTED ON THE UNDERSIDE OF RELAY

There should be a note in this fitting guide as to where the fuse adaptor plugs in to your fuse box – this will give you your KEY ON power supply and signal wire to the relay (pin 86)

Your Relay needs an earth, so you run the PIN 85 wire to Earth (battery or body)

Your relay needs a Power feed direct from battery – battery direct to PIN 30 (red wire coming from relay)

Your RED fan power wire from blue fan controller connects to this pin (as the 2 pin female plug on the end) connects to PIN 87A (blue wire coming from relay)

Your Black fan earth wire should ideally go to chassis or even back to the battery

Now you can plug that two wire female into the blue fan controller

Then you take the fan speed controller with its 3 wire plug (but is 5 pins wide if I recall) and plug it directly into the blue fan controller also, and insulate it and keep it nearby to fan controller – adjust it for 60% of maximum speed once its all going

Then, plug the motor and its wide connection plug directly into the blue fan controller as well

If you have all that completed correctly, your fan will start and run when the key is turned on

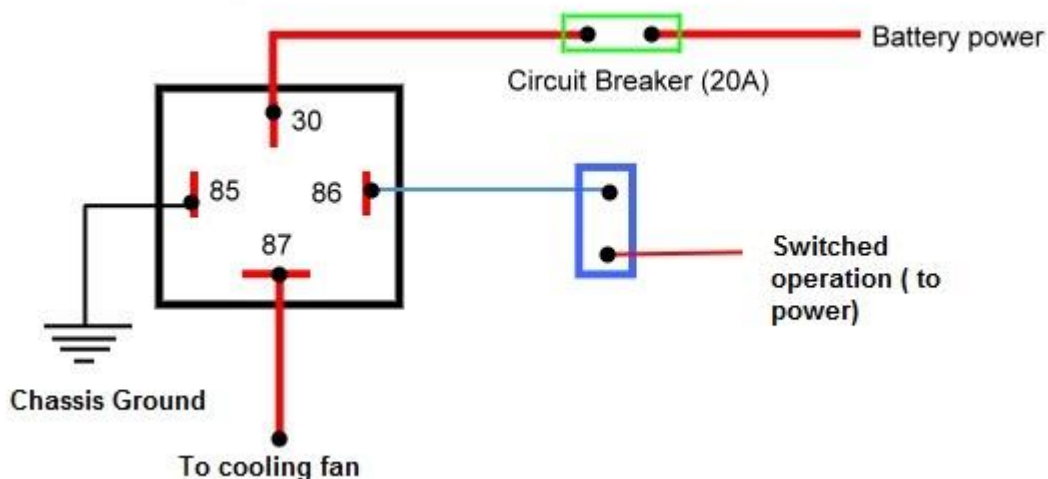

Important:

After installation of the drive belt. Check the clearance of the camshaft control wire/plug to the drive belt. There should be a minimum of 10mm clearance. If it is less, loosen the button head allen bolts and the power steering main bracket bolts and rotate the entire bracket until the desired clearance is achieved and then tighten all bolts again.

ENGINE COVER

- You have been supplied with 2 small stainless straps to mount in place of the original locations for the rear mounts of the engine cover. Bolt these into place using the supplied 6mm thread screws, your cover can now mount as normal.

2. FINAL CHECKS BEFORE STARTING VEHICLE (some of them)

- Check all bracket bolts are tightened
- Check that all the idler retainers on the bracket are tight
- Check bonnet support rod doesn't rub on drive belt. If it does it is advisable to remove the support rod and store in the boot.
- Check air delivery hose clamps are secure
- Check airflow meter wires are plugged in
- Check that the drive belt is properly fitted into the grooves on EVERY grooved pulley
- Check all wiring is secured and zip tied.

3. ENGINE START UP

- When you are 100% certain that you have properly installed all parts you are ready for engine start up, always be ready to instantly shut down the engine should unusual sounds occur REVIEW YOUR WORK. The supercharger may whine quite loudly since the transmission needs to bed in – nothing wrong.

4. ENGINE COVER FITTING

- Now that your engine has been run and you are entirely satisfied you have fitted the system properly you should now fit the Subaru engine cover. First you will note that the bracket with the 2 rubber mounts at the front of the motor now

overlaps onto your supercharger bracket and is on a slight angle forward. Simply take a rubber mallet and tap/bend the bracket back into the void in the supercharger mounting bracket until it approximately aligns with the other side.

- Now take the 2 stainless steel mounting strips and fit these in the position the rear resonance box used to occupy, fasten with the provided 6mm bolts but only tighten after you have test fitted the cover and aligned them. Now fit your cover using the factory supplied fasteners.

OPTIONAL MAP SENSOR



<http://www.rallysportdirect.com/Omni-Power-MAP-SUP-3BAR-3-Bar-MAP-Sensor>

Using Intercoolers

Optional Intercooler – you source this yourself

If you chose air to air, this is only type recommended – vertical flow by TREADSTONE USA

You need to use BOV on hot side and BOV on cold side – use same valve type as on the non intercooled kit. ATA intercoolers can be very troublesome with boost loss/flow restrictions

DO NOT EVER USE A CROSSFLOW TYPE INTERCOOLER WITH THIS SUPERCHARGER TYPE –



Servicing suggestion

Item	Product	Frequency	
Engine oil service	5/40,	6000km	
Sparkplugs	OEM in NGK Ruthenium spec	Every 70 000k	
Engine belt	6PK2275	Once a year	
Auto trans fluid	Every 25000km		
Fuel	98 octane only	ALWAYS	
Engine water level	Subaru Coolant	Weekly check	

Fitted images



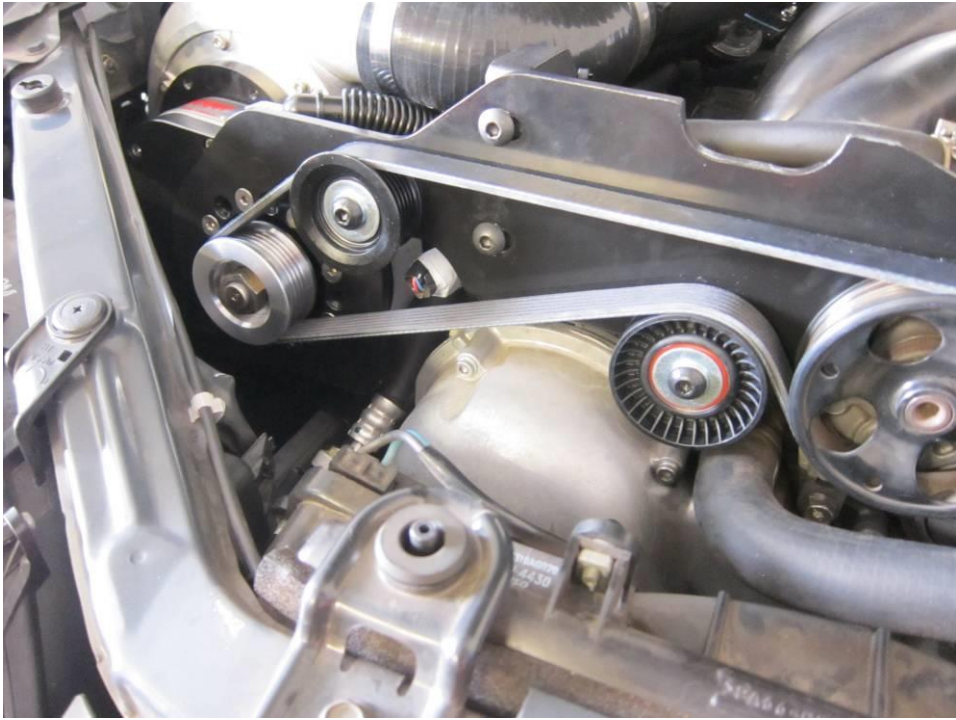







Email: raptorsc@westnet.com.au

Ph: 0409 897 081

International: 61-0409897081

Fitment of kits and systems

No liability whatsoever (including liability in negligence) is accepted by Raptor Superchargers for the fitment of incorrect tuning or incorrect fitment of kits and systems. The onus is clearly with the fitter to ensure the kit supplied is correct for the particular system. Any damage to parts or consequential damage or cost resulting from the fitment of the incorrect parts or incorrect fitment of parts is totally the responsibility of the fitter

Fuel systems

All Raptor Supercharger systems are fashioned to give adequate fuel enrichment on unmodified vehicles. If vehicle engine is modified (ie extractors, air filter pod, fuel pumps, manifolds, etc) most kits will require additional enrichment not provided with kit/s. Raptor superchargers is in no way liable for engine damage arising due to incorrect tuning, un-maintained fuel systems and the like.

Insurance

Take care to inform your vehicle insurer of changes you are making/have made so that you retain your policy, also enquire with your state transport department regarding engineering certificates/mod plates that they may require for lawful motor vehicle operation.

Lawful operation

It is your responsibility to make certain that your vehicle complies with the rules, regulations of your particular country, state or town.